

WARRANTY

We strive to offer high-quality products, and we also try our best to satisfy each and every customer that orders from us with product or service as needed.

Each customer must provide a record of their order such as the order number, or item receipt for any items that are out of the warranty period you may also still receive replacement parts by purchasing them with our company if they are available.

**Are you having difficulty
with assembly? Missing parts?**

Please contact us : info@firstopintl.com

telephone No.:5627813327

send email with your order No. to

**For return, please check the return policy with
the retailer or market place you bought from.**

Appreciate your purchasing from us.

Pop up your life by our furniture !

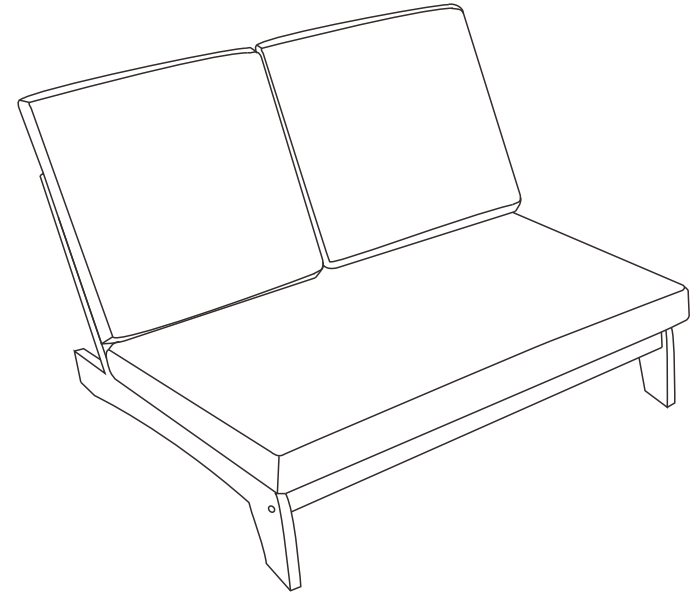
The logo for Wixe, featuring the word "wixe" in a bold, lowercase, sans-serif font. The letter "i" is stylized with a grey dot and a vertical bar.

**ITEM NO.: FOP-ODF518882001
FOP-ODF518882002**

NOTE:

This brochure contains IMPORTANT safety info. Please read and keep for future reference.

MAINTAINANCE AND WARNING

- Keep furniture away from heat and fire.
- Keep furniture away from sharp objects.
- Do not clean furniture with harsh cleansers or polish. Do not use detergents, Solvents, abrasives, spray packs or leather cleaner. Use non-color mild soap with warm water clean spills(Mix 1:10 soap to water)
- Do not place furniture under direct sunlight, material will possibly fade over time.
- Do not jump or strike on the furniture.
- Do not write on furniture without a padded barrier to protect the surface.
- Not for commercial use, For residential use only.



Weight Limitation

400LBS

PARTS LIST

Ax1

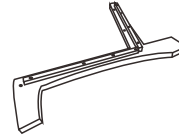

Left legs

Bx1

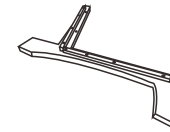

Right legs

Cx1



Back frame

Ex1

Dx1



Seat frame

Fx1

Ex1

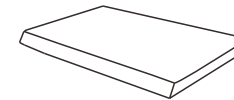

Seat cushion

Gx1

Fx2



Back cushion

Gx1



Stretcher

Hx1



Cover of
seat cushion

I x 2



Cover of
back cushion

HARDWARE and TOOL LIST

① x2



M6*40MM
Bolt

② x8



M6*45MM
Bolt

③ x1

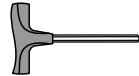

Allen key

④ x2



Plastic cover

⑤ x2



Wood dowel

Be sure to check all packing materia fit the packing list. Carefully for small parts, which may have come loose inside the carton during shipment.

ASSEMBLY INSTRUCTIONS

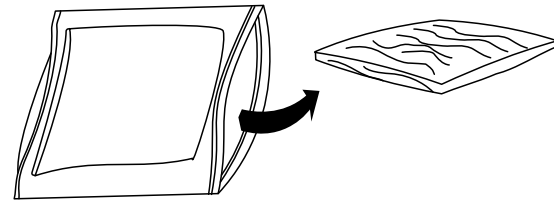

STEP 1: Take the back cushions and seat cushions from the vacuum bags, let them expand for a while.

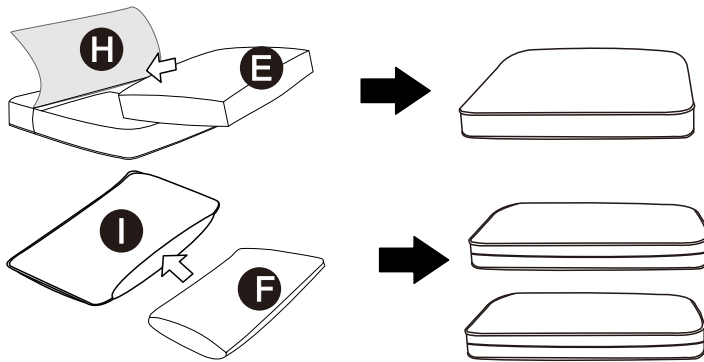

 It will take a while for the cushions to expand. Normally it will take up to around 24 hours to expand to its full size.

STEP2: Put seat cushions(E) and back cushions(F) into covers (H,I), and zip up.

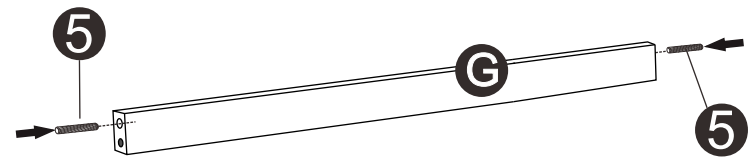

STEP 3: Insert wood dowel(5) into holes at both ends of stretcher(G).

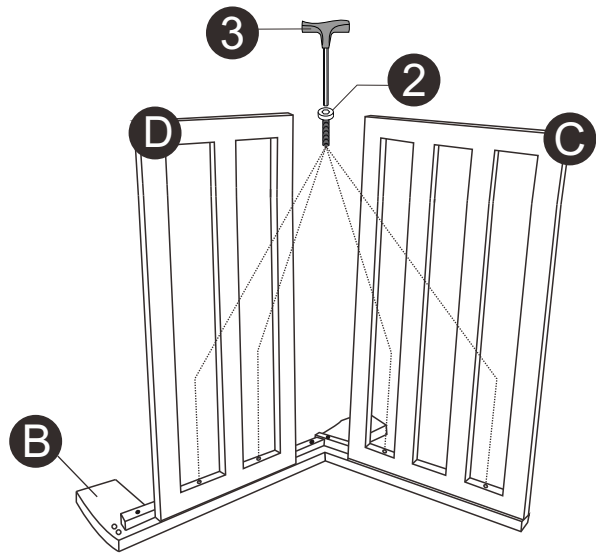

STEP 4: Connect seat frame and back frame to right legs with bolt(2) and allen key(3).

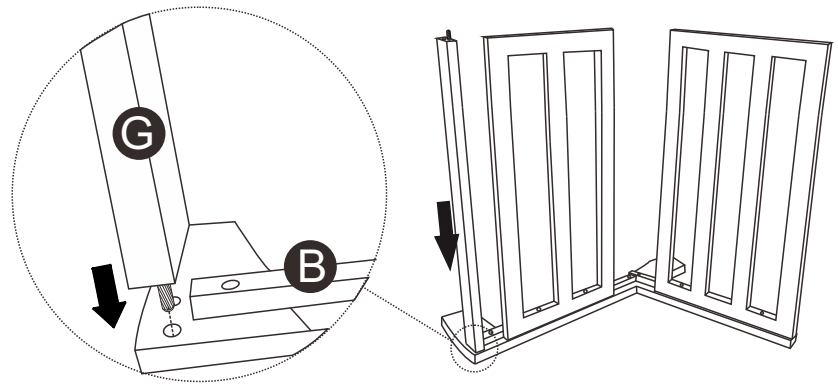

STEP 5: Connect stretcher(G) to frame (step 3).

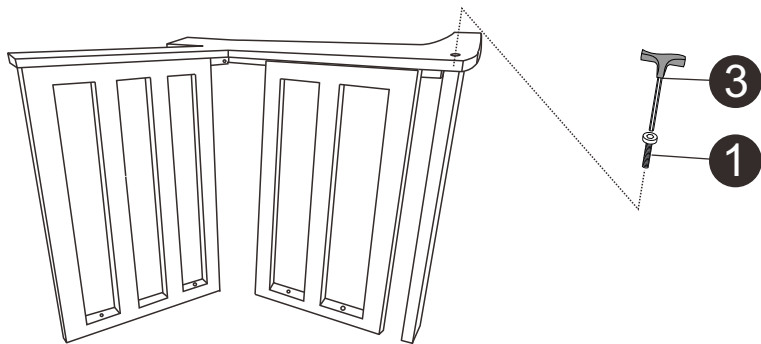

STEP 6: Invert the frame (step 4), fix the stretcher with bolt(1) and allen key(3).

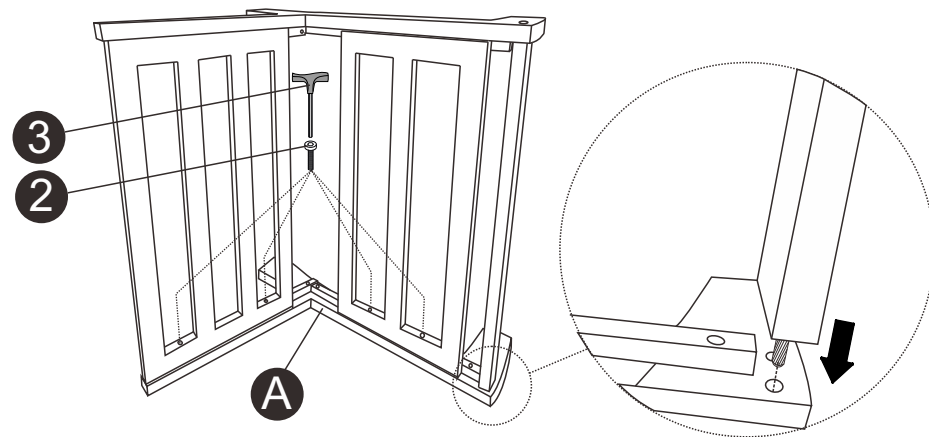

STEP 7 : Place frame (step 6) to left legs(A), fix with bolt (2) and allen key (3).

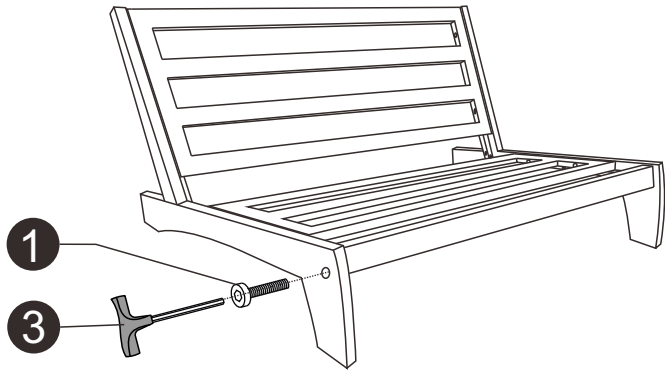

STEP 8: Fix the left end of stretcher with bolt(1) and allen key(3).

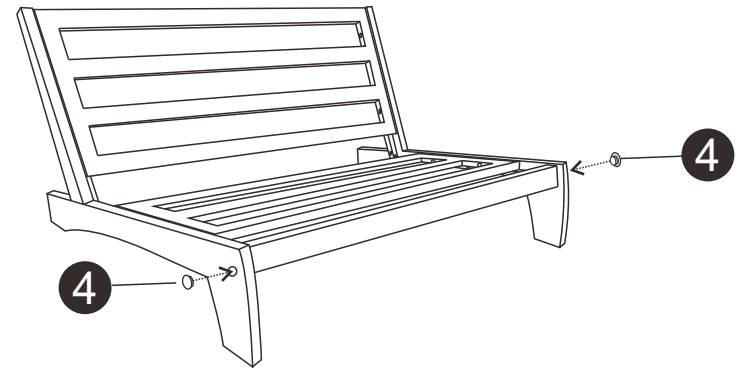

STEP 9: Cover the screw holes on both sides of legs with plastic cover (4).

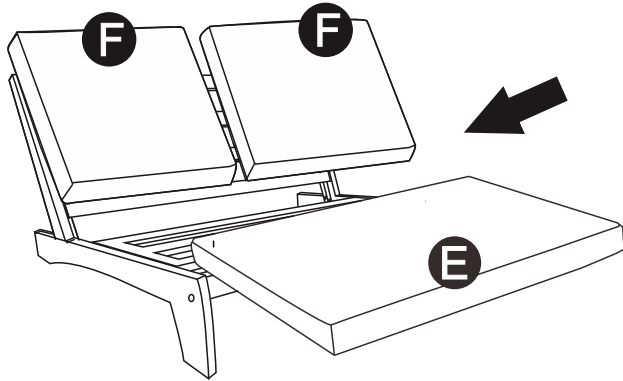

It will take a while for the cushions to expand.
Normally it will take up to around 24 hours to
expand to its full size.

STEP 10: Place seat cushion (E) on seat frame, and
place back cushion(F) on back frame.

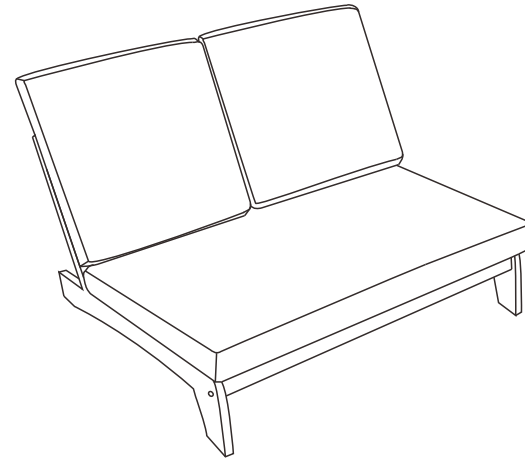

STEP 11: Assembly completed.